

TECHNICAL DATA GSA-115

Flight Illusion Small Single Needle Assembly

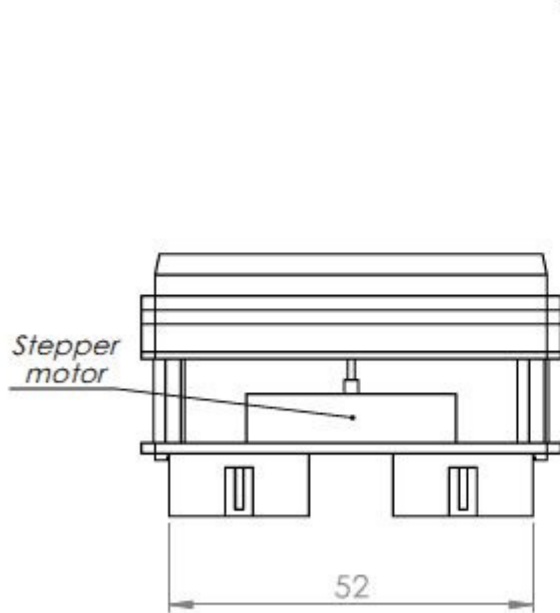

Viewable area diameter 47 mm

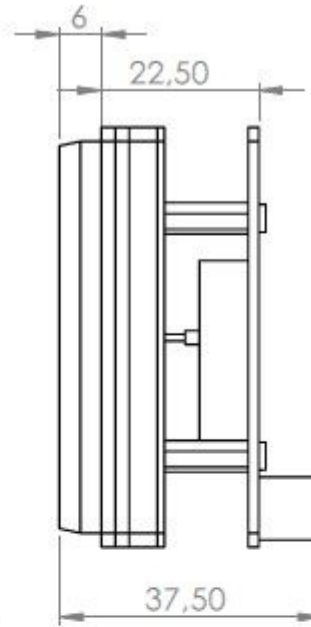
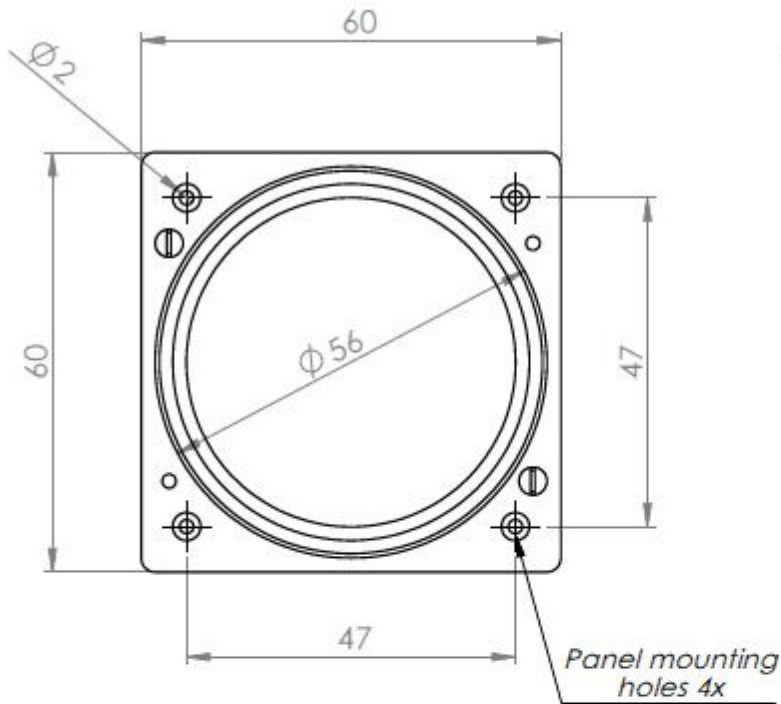
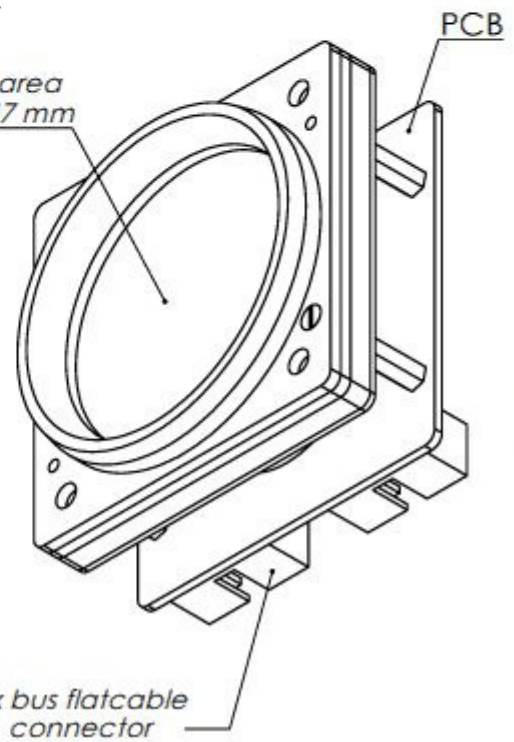

All dimensions are in mm

MODEL		GSA-115
INPUT	DC VOLTAGE	5V
	RATED CURRENT	60mA
	CURRENT RANGE	20mA – 60mA
	RATED POWER	300mW
	VOLTAGE RANGE	4.5 ~ 5.2V
	SETUP TIME (AFTER POWERUP)	2000 mS
OUTPUT	NEEDLE RESOLUTION (BOTH NEEDLES)	1080 steps / 0,33 degrees per step
	STEPS (FULL SCALE, BOTH NEEDLES)	1080
	MAX NEEDLE SPEED (BOTH NEEDLES)	600 degrees / second
	MAX ANGLE	120 degrees (for both needles)
	RESPONSE TIME (AFTER RECEIVING COMMAND)	
	BACKLIGHT COLOR TEMPERATURE	570nm
PROTECTION	UNDER VOLTAGE	Below 4.3V: Gauge will be switch off, recovers automatically after voltage raise above 4.3V
ENVIRONMENT	WORKING TEMP.	-20 ~ +50°C
	WORKING HUMIDITY	20 ~ 90% RH non-condensing
	STORAGE TEMP., HUMIDITY	-40 ~ +55°C, 10 ~ 95% RH
	TEMP. COEFFICIENT	±0.03%/°C (0 ~ 50°C)
	VIBRATION	10 ~ 500Hz, 5G 10min./1cycle, 60min. each along X, Y, Z axes
OTHERS	MTBF	95K hrs
	DIMENSION	83x83x40 (mm)
NOTE	1. The gauge is considered a component which will be installed into a final equipment. The final equipment must be re-confirmed that it still meets the requirements	
	2. Length of set up time is measured at first cold start. Turning ON/OFF the gauge may lead to increase of the set up time.	



**FLIGHT
ILLUSION**

more than simulation